



The BRX logo is a blue square with the letters 'BRX' in white. The 'X' is stylized with a white triangle pointing to the right.

TECNOLOGIA SARTORIALE

TAILORED PROJECTS

BRX UNISCE DIVERSE PROFESSIONALITÀ AD UN'ESPERIENZA VENTENNALE NEL SETTORE DELLA LAVORAZIONE DI ACCIAIO E REFRIGERAZIONE. IL RISULTATO: PRODOTTI TECNOLOGICI D'AVANGUARDIA, NELL'ESTETICA E NELLA FUNZIONALITÀ, FRUTTO DI UNA RICERCA COSTANTE E DI UN RAPPORTO DI DIALOGO E ASCOLTO CON LA COMMITTENZA. LA COMPETENZA E LA PASSIONE DELL'AZIENDA FANNO DA SUPPORTO PROGETTUALE A STUDI TECNICI, ARCHITETTI E ARREDATORI PER CREARE SOLUZIONI SEMPRE PIÙ PERSONALIZZATE: NASCONO COSÌ PROGETTI "SARTORIALI", PERFETTI SOTTO OGNI PROFILO, PRATICI NELL'UTILIZZO E DUREVOLI NEL TEMPO. QUESTA È LA VERA FORZA DELL'AZIENDA: CREARE SEMPRE PRODOTTI IN LINEA CON LE ESIGENZE DEL CLIENTE, GARANTENDO UN SUPPORTO COSTANTE E COMPETENTE IN OGNI FASE, DALL'IDEA ALLA SUA REALIZZAZIONE.

BRX COMBINES A TEAM OF SKILLED PROFESSIONALS WITH TWENTY YEARS OF EXPERIENCE IN THE FIELD OF STEEL PROCESSING AND REFRIGERATION SYSTEMS. THE RESULT: CUTTING-EDGE TECHNOLOGICAL PRODUCTS, BOTH FOR THEIR AESTHETICS AND FUNCTIONALITY, THE RESULT OF CONSTANT RESEARCH AND THE ABILITY TO TALK AND LISTEN TO THE CUSTOMER. THE COMPANY'S EXPERTISE AND PASSION OFFER DESIGN SUPPORT AT THE SERVICE OF TECHNICAL STUDIOS, ARCHITECTS AND INTERIOR DESIGNERS TO CREATE MORE AND MORE CUSTOMIZED SOLUTIONS: TRULY "TAILORED" PROJECTS, PERFECT UNDER EVERY POINT OF VIEW, PRACTICAL IN THEIR APPROACH AND LONG LASTING. THIS IS THE REAL POWER OF THE COMPANY: CREATING PRODUCTS IN LINE WITH THE CUSTOMER'S NEEDS, GUARANTEEING CONSTANT AND COMPETENT SUPPORT AT EVERY STAGE, FROM IDEA TO IMPLEMENTATION.



INDEX

- 6/7 **PROGETTI SARTORIALI** TAILORED PROJECTS
- 14/15 **GELATERIA** ICE CREAM PARLOUR
- 38/39 **SELF** SELF
- 64/65 **PASTICCERIA** PASTRY
- 80/81 **BANCHI BAR** BAR COUNTERS



PROGETTI SARTORIALI

TAILORED PROJECTS

Personalizzare significa seguire le esigenze dei nostri clienti: sia nello standard che nel su misura, proponiamo sempre soluzioni flessibili in grado di creare ambienti unici.

Customizing means following the needs of our customers, both for standard and custom products, always offering flexible solutions capable of creating unique environments.

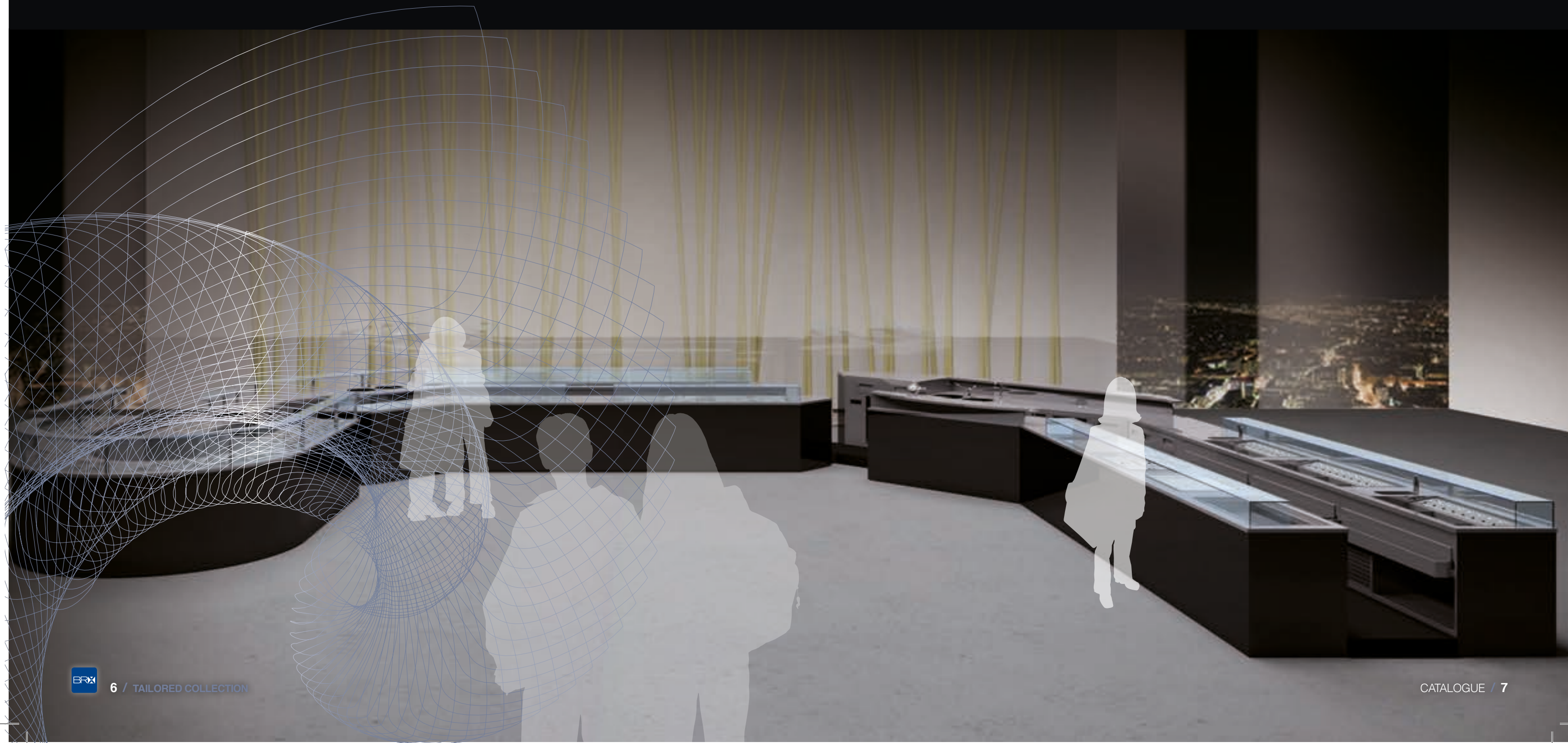



DAL DISEGNO ALLA SUA REALIZZAZIONE.

FROM THE DRAWING STAGE TO ITS IMPLEMENTATION.

Un team di professionisti segue il cliente in ogni sua esigenza. Un supporto indispensabile a studi tecnici, arredatori, architetti e professionisti.

A team of professionals follows the customer every step of the way. This is an essential support for technical studios, interior designers, architects and design professionals.

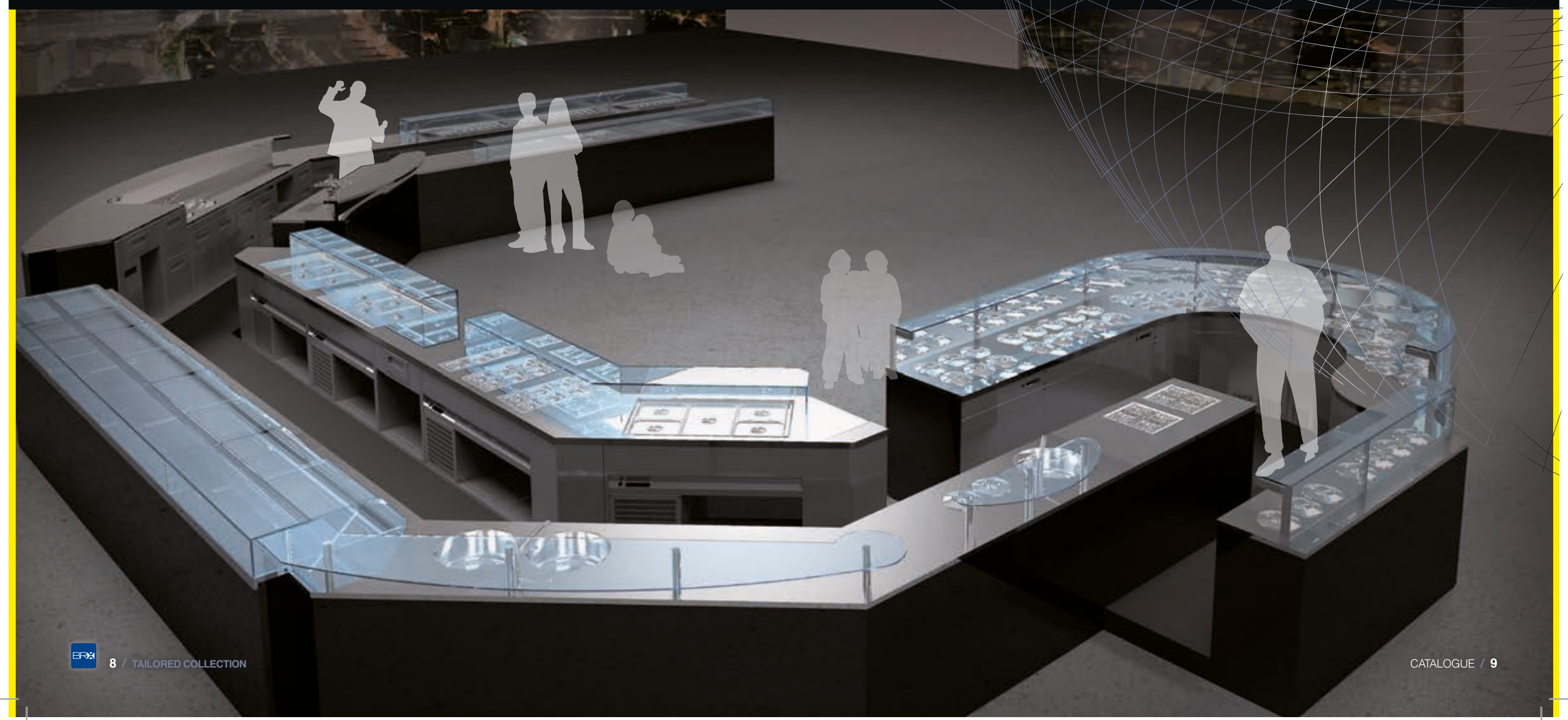



PER OGNI SPAZIO, ANCHE SU MISURA

FOR EVERY SPACE, EVEN CUSTOM MADE.



Caratteristica di BRX è la realizzazione di progetti sartoriali avvalendosi di tecnologie d'avanguardia senza dimenticare la qualità e l'artigianalità della tradizione.

BRX distinguishes itself for the implementation of tailored projects using cutting-edge technologies without forgetting the quality and craftsmanship rooted in its tradition.

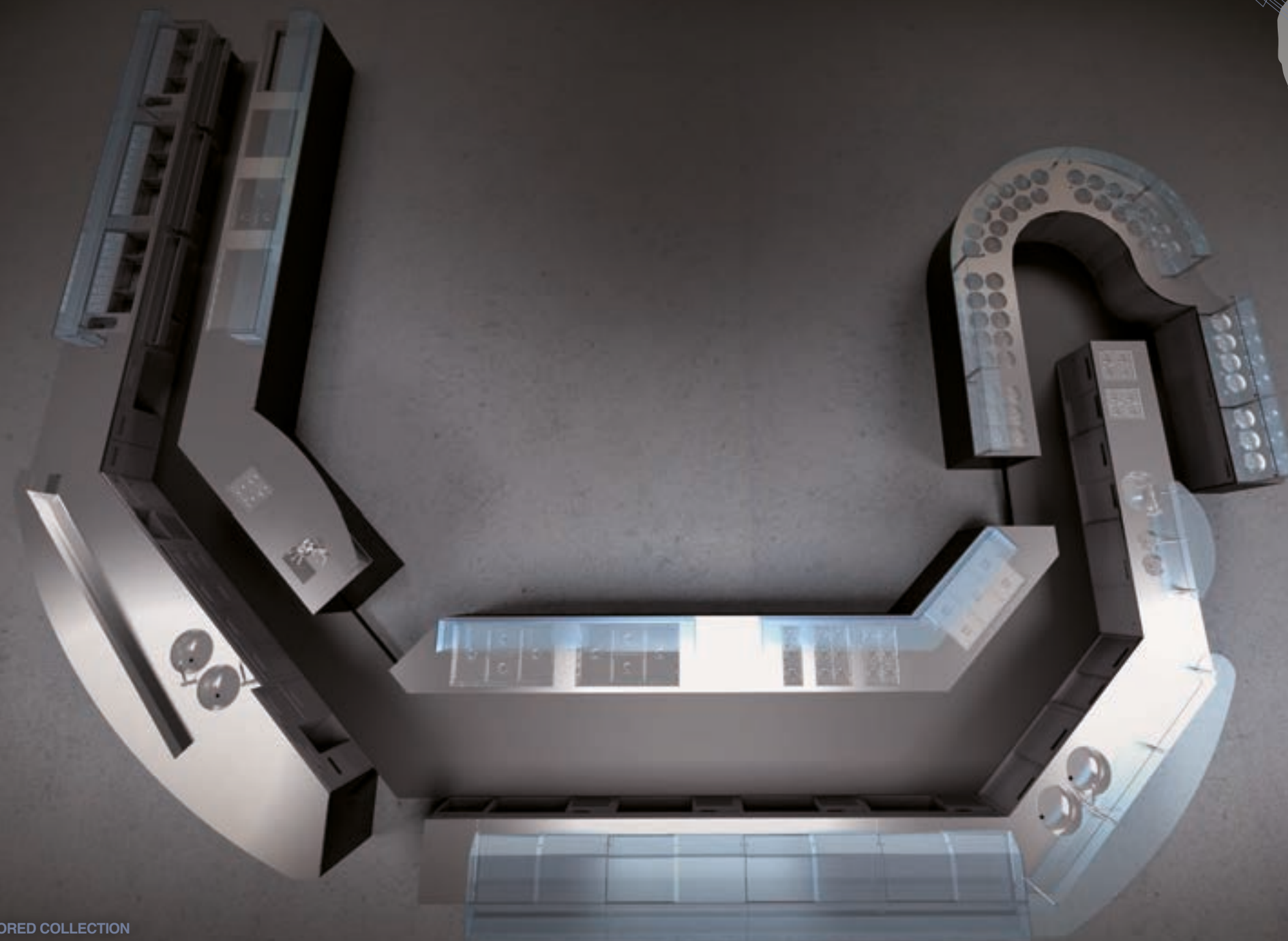



LA QUALITÀ VISTA DA VICINO

QUALITY UP CLOSE AND PERSONAL



LAVORAZIONI RIFINITE E DETTAGLI
CURATI PER PRODOTTI COMPLETI

REFINED PROCESSING AND CARED
FOR DETAILS IN ALL FINISHED PRODUCTS



GELATERIA

ICE CREAM PARLOUR



BANCHI GELATERIA PER PERSONALIZZARE IL TUO SPAZIO: FUNZIONALITÀ E BELLEZZA SU MISURA PER PROGETTI UNICI.

ICE CREAM COUNTERS TO CUSTOMIZE YOUR SPACE: FUNCTIONALITY AND BEAUTY CUT TO SIZE FOR UNIQUE PROJECTS.

Moduli lineari e angolari si abbinano con una pratica disposizione dei contenitori gelato a cui si affiancano le vaschette per le guarnizioni calde e le farciture fresche. La scelta dei pozzetti detta nuove regole di tendenza, non solo per l'estetica, ma soprattutto per una migliore conservazione, freschezza, igiene dei prodotti e risparmio energetico. Ed è la scelta dei professionisti del gelato artigianale.

Linear and corner modules combine in a practical set up of ice cream tubs, hot and fresh toppings trays. The choice of integrated tubs sets new trends not only for its aesthetics, but also for better preservation, freshness and hygiene of products, together with energy savings. This is the choice of professional ice cream makers.

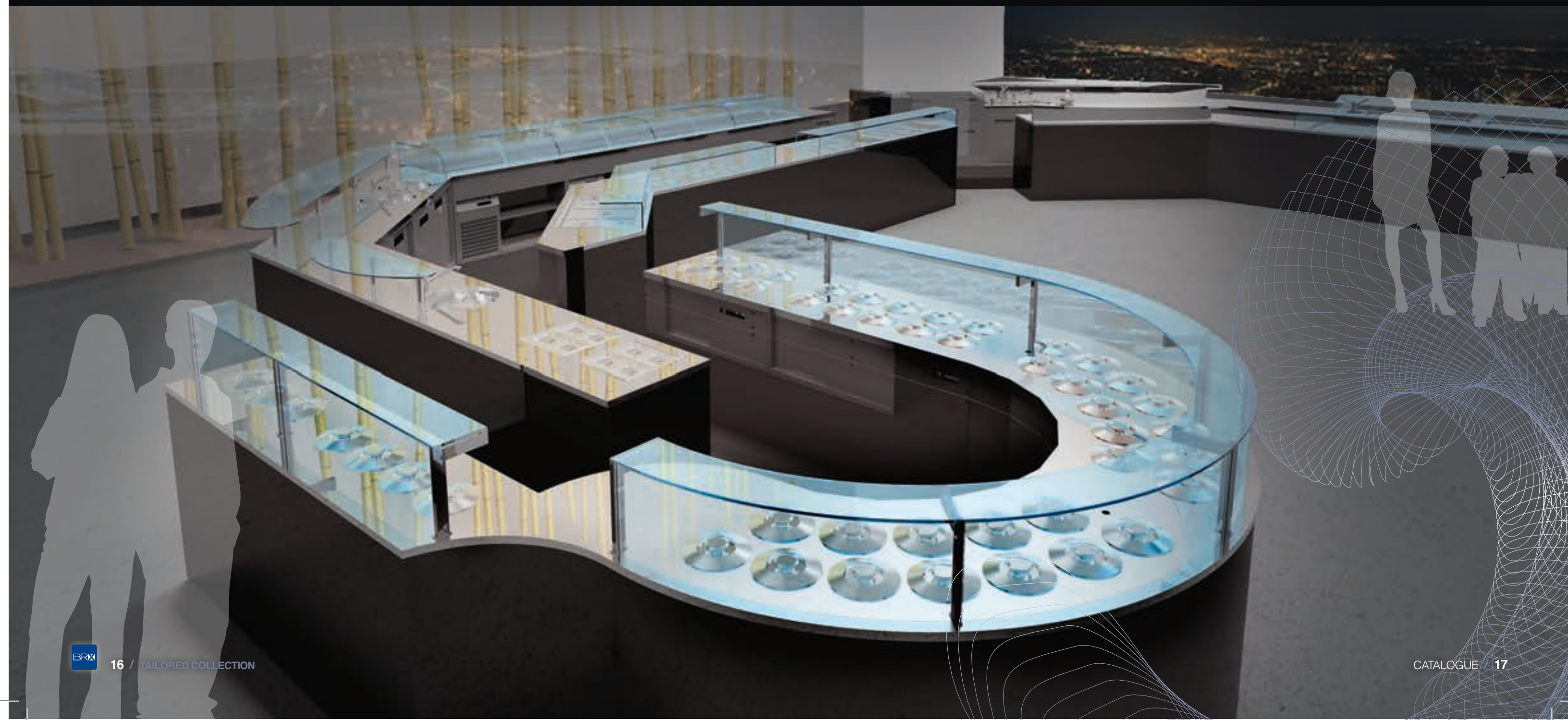

DEDICATO A CHI FA DEL PROPRIO LAVORO UNA VERA ARTE

DEDICATED TO THOSE WHO LOVE
TO TURN THEIR JOB INTO A WORK OF ART

LA TRADIZIONE SI RINNOVA COME LE GELATERIE DI UN TEMPO, LA SOLUZIONE CON CONTENITORI A POZZETTO RECUPERA NELL'ESTETICA E NELLA PERFETTA CONSERVAZIONE DEL PRODOTTO LA FILOSOFIA DEL GELATO ARTIGIANALE.

TRADITION RENEWS ITSELF LIKE THE ICE CREAM PARLOURS OF THE PAST, THE CYLINDER TUBS RECALL AESTHETICALLY AND IN THE PERFECT PRESERVATION OF THE PRODUCT THE PHILOSOPHY OF ARTISAN ICE CREAM MAKING.

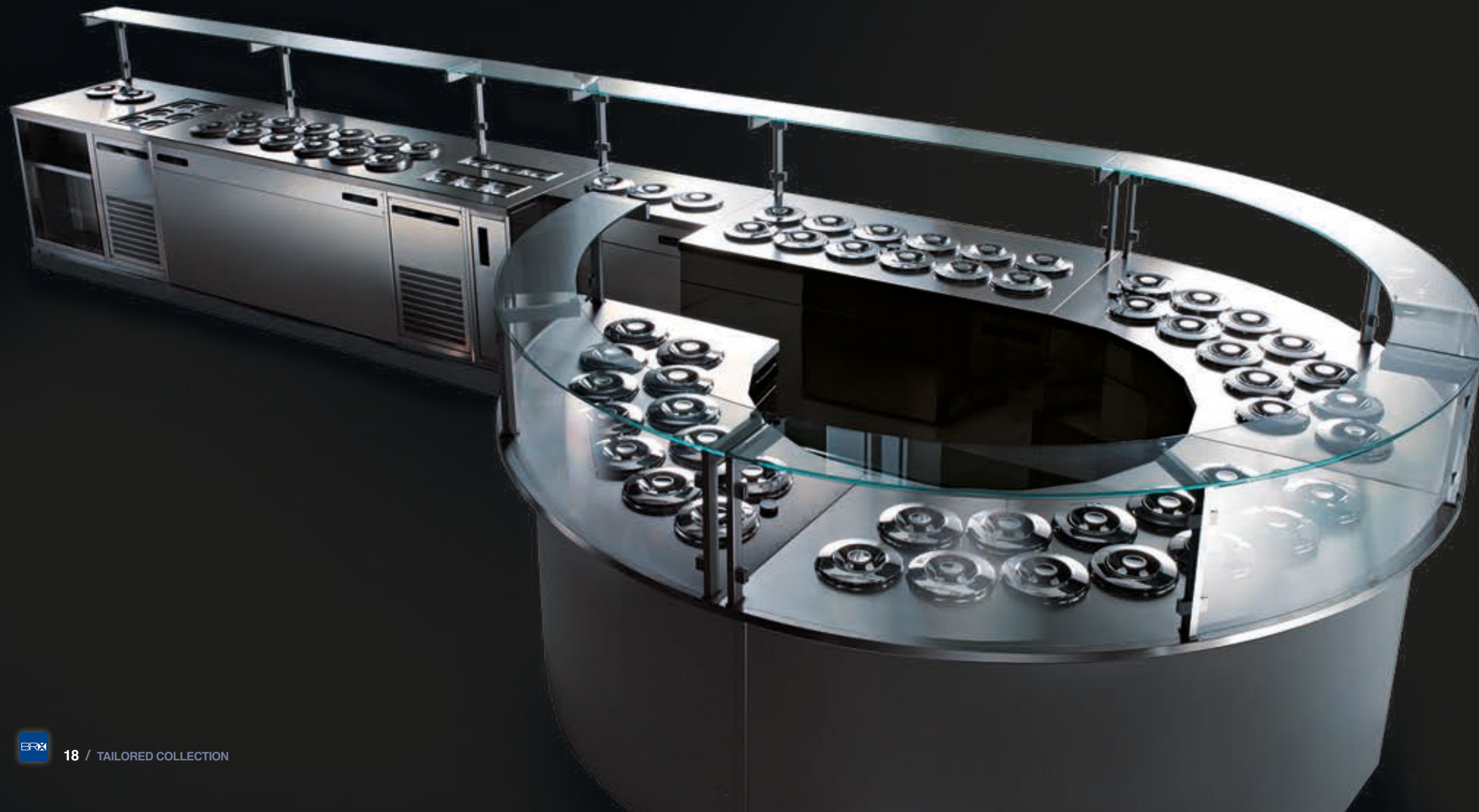

SPAZI DA PERSONALIZZARE

SPACES TO CALL YOUR OWN

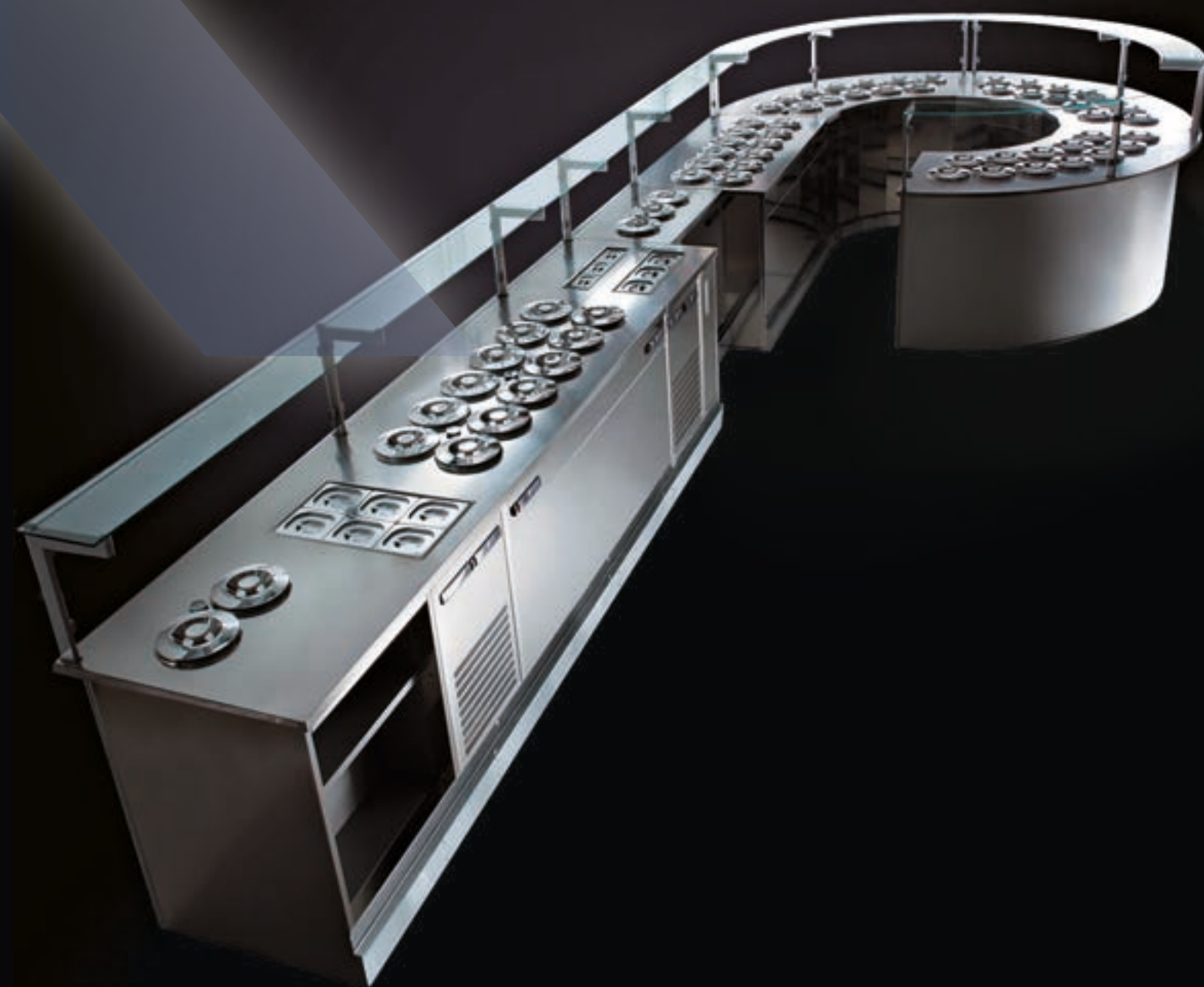



MODULI GELATERIA ICE CREAM MODULES

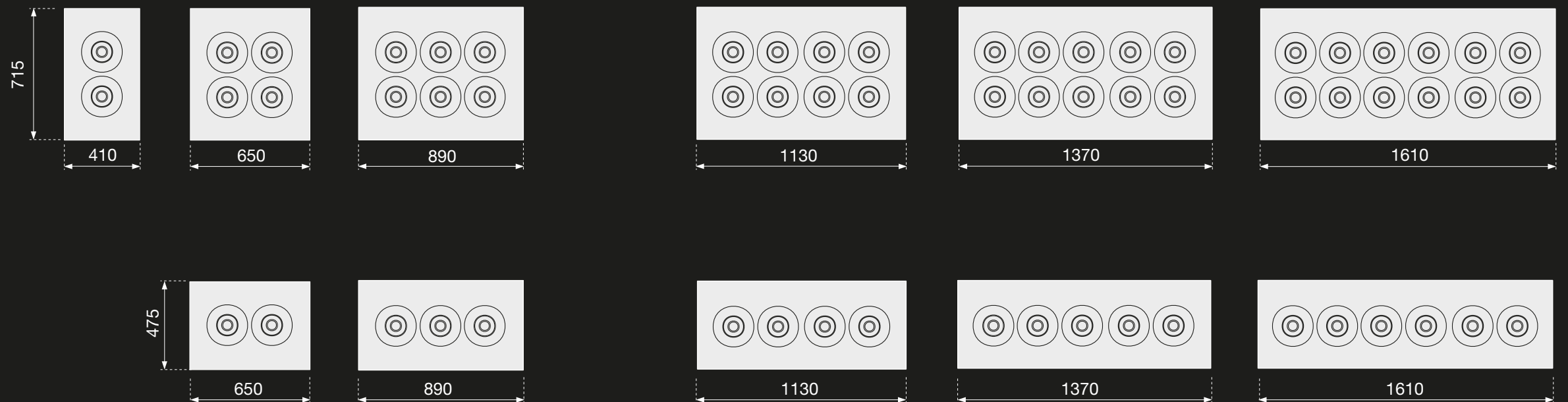
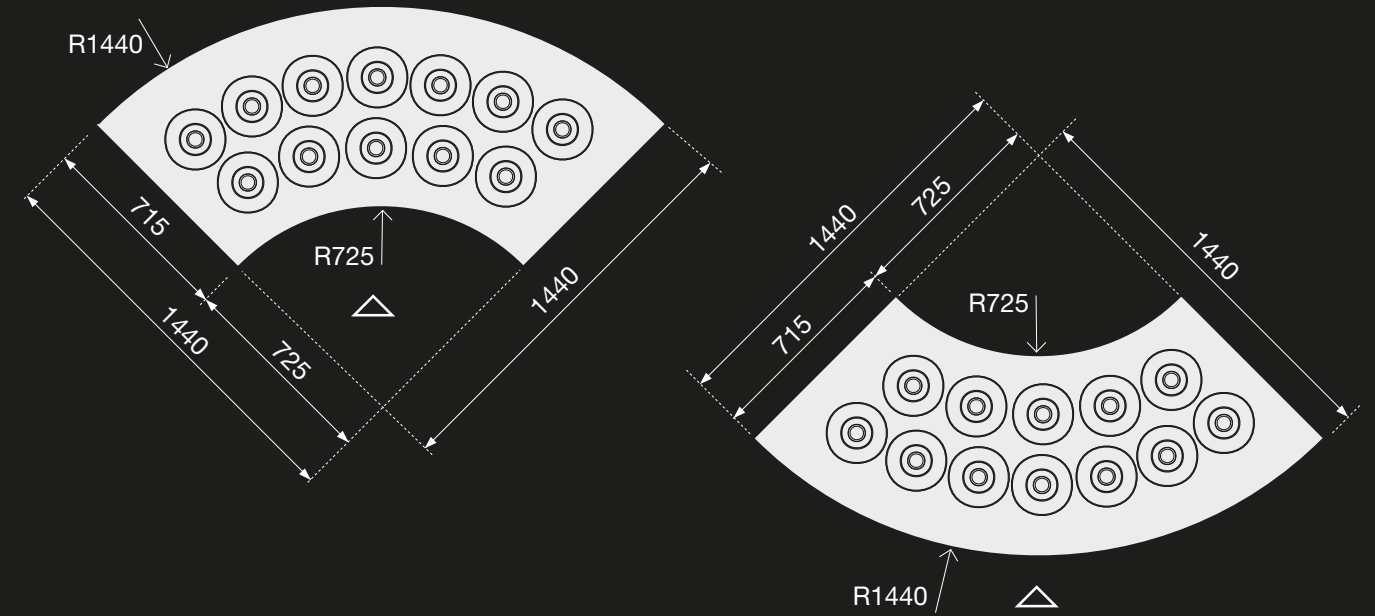
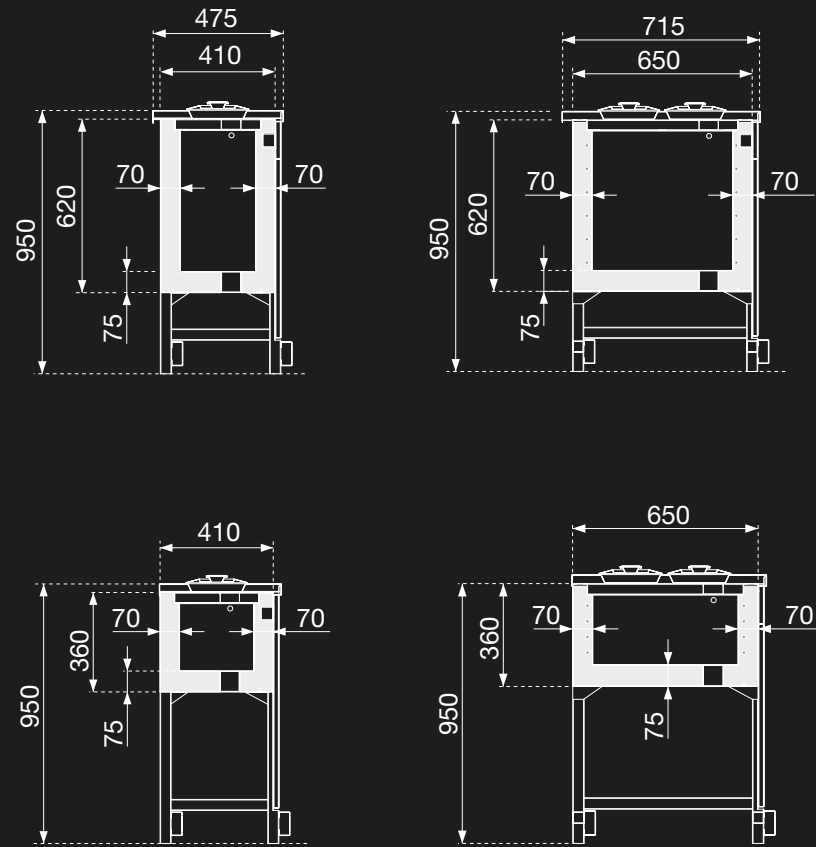





ESPOSIZIONE INNOVATIVA

INNOVATIVE DISPLAY

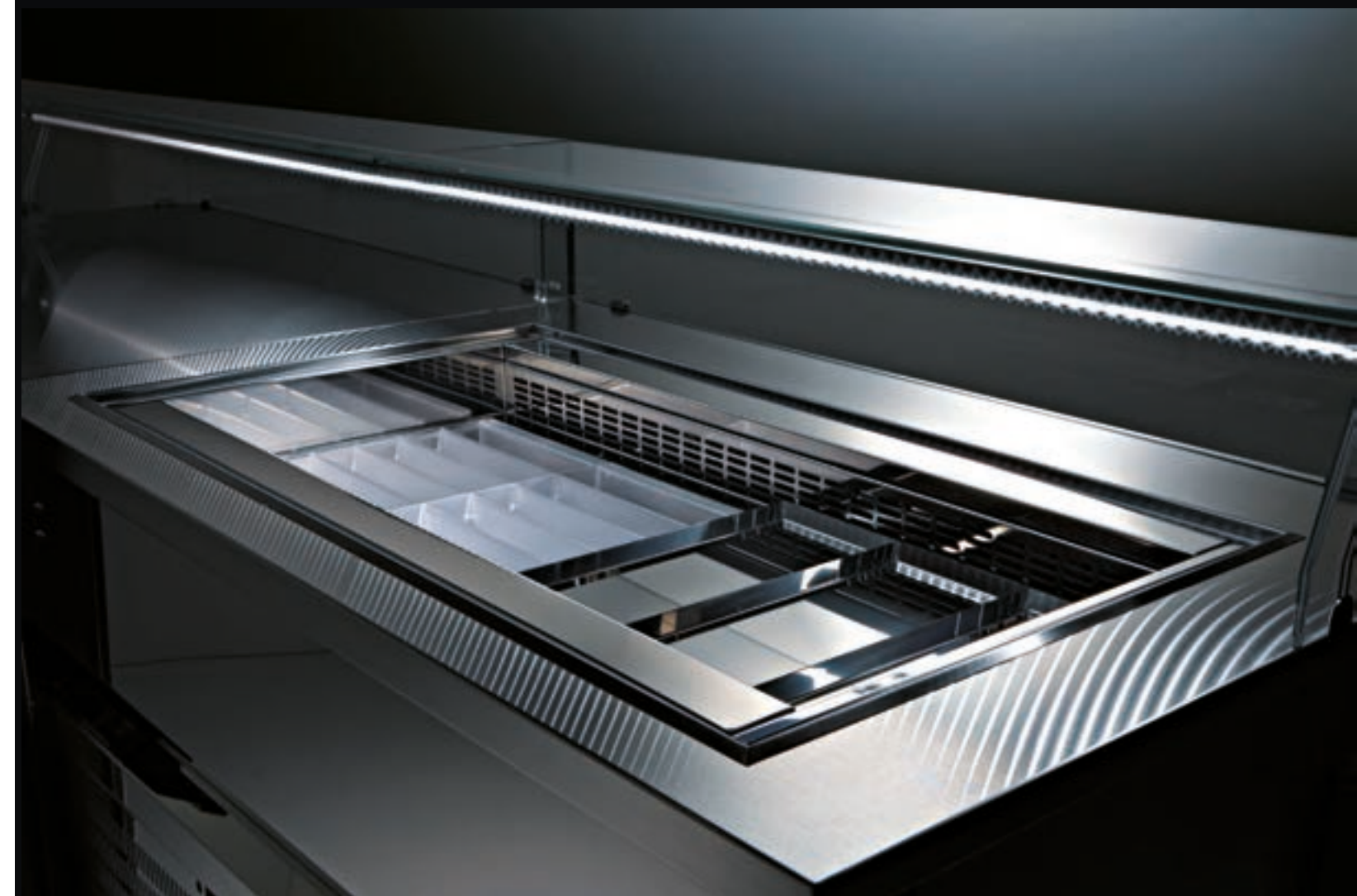

Vasche a bassa temperatura.
Piano espositivo regolabile
in altezza per contenere ed
esporre in modo innovativo
diverse tipologie di prodotto.

Low temperature trays.
Display top adjustable in height
to hold and display a variety
of products in an innovative
fashion.

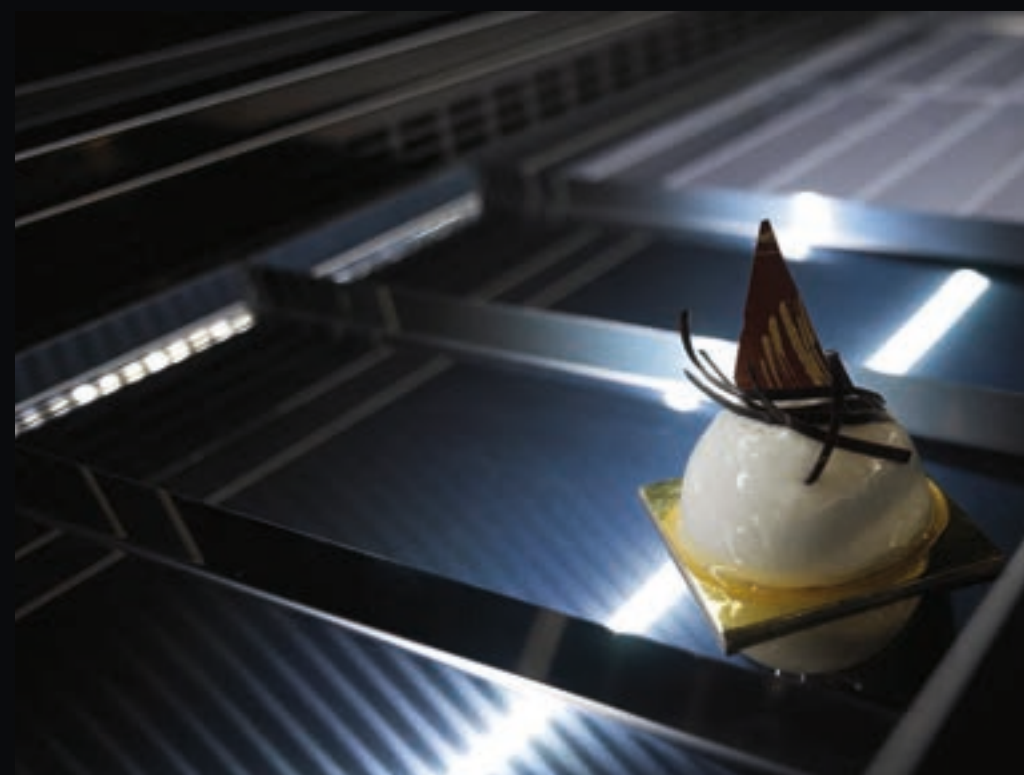

PIÙ FUNZIONALITÀ ALLA PROFESSIONALITÀ

PROFESSIONALISM MADE PRACTICAL

Lo spazio interno degli elementi è sfruttato al massimo, l'unità condensatrice ad acqua è inserita a regola d'arte. Vani ricavati in larghezza e in profondità standard e su misura.

The inner space of the equipment is maximized; the water condenser unit is installed perfectly. The compartments are standard in width and depth, but also available cut to size.



TECNOLOGIA E PRATICITÀ VISTE DA VICINO

TECHNOLOGY AND FUNCTIONALITY RIGHT BEFORE YOUR EYES



I top banchi pozzetto, standard e su misura, vengono realizzati con supporto in fibra di legno idrofugo, isolamento termico in poliuretano espanso e resistenza elettrica anticondensa.

The counter tops of the cylinder tubs, standard and custom, are manufactured with a waterproof wood fibre support and a thermal insulation in polyurethane foam. They feature an anti-condensation electrical resistance.



Particolare del troppo pieno.

Detail of overflow.



L'ERGONOMIA DEL DESIGN CURVILINEO

THE ERGONOMICS OF A CURVILINEAR DESIGN

LA COMPOSIZIONE A SEMICERCHIO ESALTA LA SINERGIA TRA LO STANDARD E IL SU MISURA.

THE SEMICIRCLE COMPOSITION ENHANCES THE SYNERGY BETWEEN STANDARD AND CUSTOMIZED SIZES.





PROGETTI INTELLIGENTI AL SERVIZIO DEL LAVORO

CLEVER PROJECTS TO SERVE YOU
WHEN YOU'RE HARD AT WORK

UN SISTEMA PERFETTO DI CONSERVAZIONE CHE ESALTA TRADIZIONE,
ARTIGIANALITÀ E PROFESSIONALITÀ PER OTTENERE SEMPRE I MIGLIORI RISULTATI.

A PERFECT PRESERVATION SYSTEM THAT ENHANCES TRADITION,
CRAFTSMANSHIP AND PROFESSIONALISM FOR ALWAYS BETTER RESULTS.



SELF



*BANCHI E VASCHE CALDO/FREDDO
STANDARD E SU MISURA, SOLUZIONI
SARTORIALI STUDIATE IN PERFETTA
SINERGIA CON I PROGETTISTI*

*HOT/COLD TRAYS AND COUNTERS, BOTH STANDARD
AND TAILORED SOLUTIONS DESIGNED
IN PERFECT SYNERGY WITH THE DESIGNERS*

Un design pulito ed elegante
che garantisce funzionalità ed
ergonomia a chi lavora. Un
rigore formale che all'interno
nasconde una tecnologia
all'avanguardia che mantiene
i cibi sempre alla temperatura
ideale.

A clean, elegant design that
provides functionality and
ergonomics to users.
Formal shapes hiding a heart
of advanced technology that
keeps food always at the ideal
temperature.



**OGNI COSA AL SUO POSTO:
DIVERSI PRODOTTI PER DIVERSE
FUNZIONI ORGANIZZATI IN PERFETTA
SIMBIOSI NELLA LORO MODULISTICA**

**EVERYTHING IN ITS PLACE: DIFFERENT PRODUCTS FOR DIFFERENT
FUNCTIONS ORGANIZED IN PERFECT HARMONY THANKS TO
THE MODULAR STRUCTURE**



LIBERA INTERPRETAZIONE DI STILE

FREE INTERPRETATION OF STYLE

VASCHE A DOPPIA LARGHEZZA DAL DESIGN ESSENZIALE E PULITO, PROPOSTE COME LIBERA INSTALLAZIONE O INSERITE NEI NOSTRI MODULI, PERMETTONO LA SCELTA PERSONALIZZATA DEI MATERIALI DI TOP E FRONTALI, SECONDO IL PROPRIO STILE.

DOUBLE WIDTH TRAYS WITH CLEAN AND BASIC DESIGN, PROPOSED AS FREE-INSTALLATION OR INSERTED IN OUR MODULES, ALLOW THE CUSTOMIZED CHOICE OF MATERIALS FOR TOPS AND FRONTS, ACCORDING TO THE INDIVIDUAL STYLE.





MODULI SELF SELF MODULES

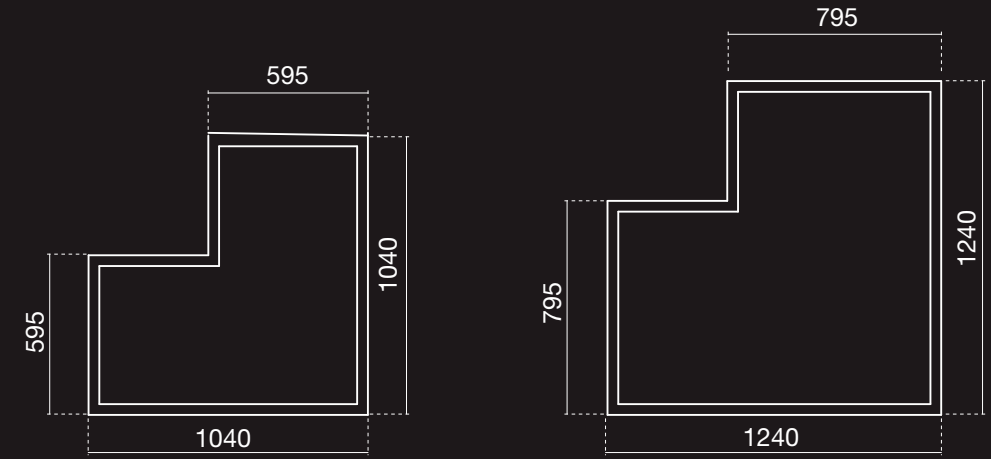
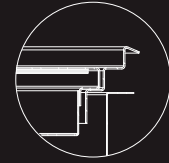
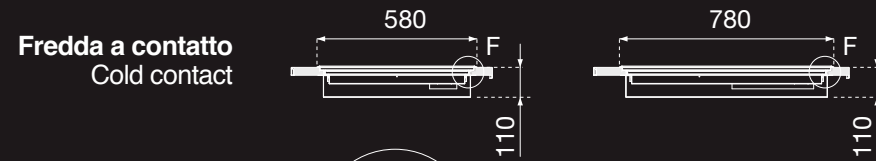
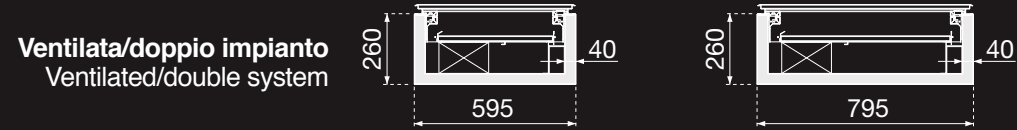
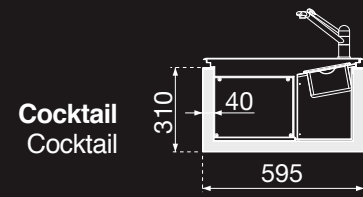

Moduli self ad angolo
Corner Self Modules

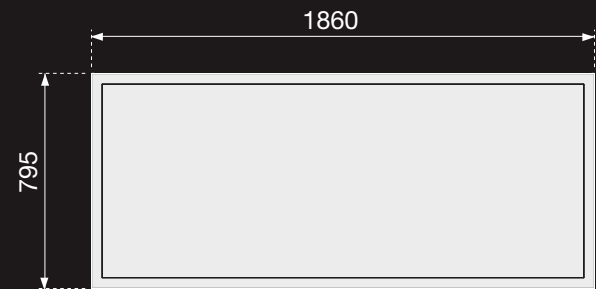
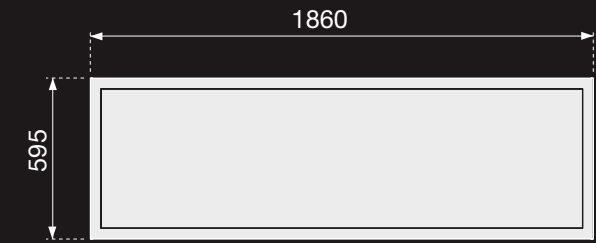
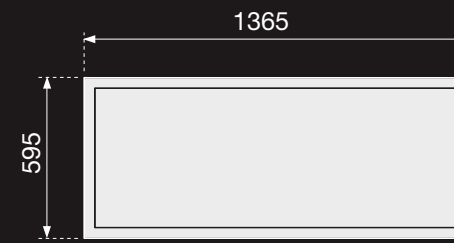
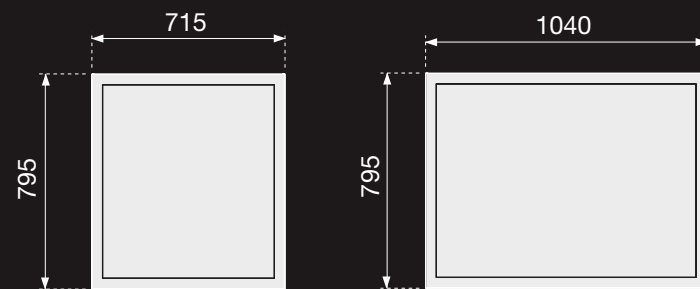
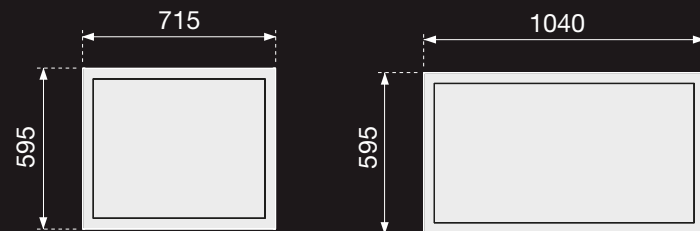

ESSENZIALITÀ PER UN MIGLIORE UTILIZZO

A MINIMALIST APPROACH FOR IMPROVED USAGE





SPAZIO A UN PROGETTO INTELLIGENTE

MAKING ROOM FOR A SMART DESIGN

Piastra in vetro pirolitico dal design rigoroso, mantiene i cibi caldi, agevola il lavoro e la pulizia dei piani.

The plate in pyrolytic glass with straight forward design, keeps the food hot, and facilitates work activities and surface cleaning.





ESPOSIZIONE IDEALE PER UNA TEMPERATURA IDEALE

IDEAL DISPLAY FOR AN IDEAL TEMPERATURE

La vasca ventilata conserva il fresco costante ed equilibrato ideale per la piccola pasticceria.
Il piano ribassato di pochi centimetri offre una migliore visibilità.

The ventilated tank keeps cool constant and balanced, ideal for small pastries.
the top lowered by a few centimetres offers greater visibility.



PER OGNI MOMENTO DELLA GIORNATA

FOR EVERY MOMENT OF THE DAY

Piastra refrigerata o riscaldata in acciaio che offre una perfetta esposizione dei prodotti.

The cooled or heated plate in steel offers a perfect product display.





PERFETTA CONSERVAZIONE DEL GUSTO

PERFECT PRESERVATION OF TASTE



Le vasche riscaldate internamente mantengono il giusto calore degli alimenti e sono dotate di coperchi per una perfetta igiene.

The tanks, internally heated, maintain the right food temperature and are equipped with lids for perfect hygiene.

FLESSIBILITÀ CHE FA LA DIFFERENZA

FLEXIBILITY THAT MAKES
THE DIFFERENCE



Ottimizzazione degli spazi grazie alla personalizzazione delle misure su richiesta: le celle frigorifere sono ridimensionate sulla profondità delle vasche e sono posizionate sotto banco per avere tutto a portata di mano.

Optimization of space thanks to the customization of dimensions on demand: the refrigerator units are resized according to the depth of the tanks and are placed under the counter to keep everything close at hand.





DALLA COLAZIONE AL PRANZO, DALL'APERITIVO AL DOPOCENA, I BANCHI E LE VASCHE SELF SONO LA SOLUZIONE IDEALE GRAZIE ALLA MASSIMA PERSONALIZZAZIONE, LA CURA PERFETTA DEI DETTAGLI E LA PULIZIA FORMALE. PER GARANTIRE MASSIMA EFFICIENZA A CHI LAVORA E MASSIMO COMFORT AI CLIENTI.

FROM BREAKFAST TO LUNCH, FROM APERITIF TO AFTER DINNER, THE SELF-SERVICE TANKS AND COUNTERS ARE THE IDEAL SOLUTION THANKS TO THEIR MAXIMUM CUSTOMIZATION, PERFECT CARE FOR DETAILS AND LINEAR DESIGN. THEY ENSURE MAXIMUM EFFICIENCY TO USERS AND MAXIMUM COMFORT TO CUSTOMERS.

PASTICCERIA

PASTRY



*LA BELLEZZA È NEGLI OCCHI
DI CHI LA GUARDA
BEAUTY IS IN THE EYE OF THE BEHOLDER*

I banchi pasticceria sono studiati per attirare l'attenzione. Prodotti posizionati a portata di sguardo. Tecnologia come miglior supporto per la loro perfetta conservazione. Soluzioni ideali che garantiscono il massimo potere espositivo per prodotti che non passano inosservati, facili da prendere e ancora più invitanti.

The pastry counters are designed to attract attention. All products are positioned right before the eyes. Technology at its best supports their perfect preservation. Ideal solutions ensure maximum display power for products that catch the eye, that are easy to get and even more inviting.



PROGETTI NEL SEGNO DELL'ESSENZIALITÀ

PROJECTS UNDER THE FLAG OF THE ESSENTIAL



FUNZIONALITÀ A PORTATA DI MANO

HANDY FUNCTIONALITY

Perfetta integrazione con tutti i nostri moduli.
Banchi neutri a giorno o con ante per un miglior utilizzo degli spazi.

Perfect integration with all our modules.
Neutral open counters or with doors for a better use of better space.



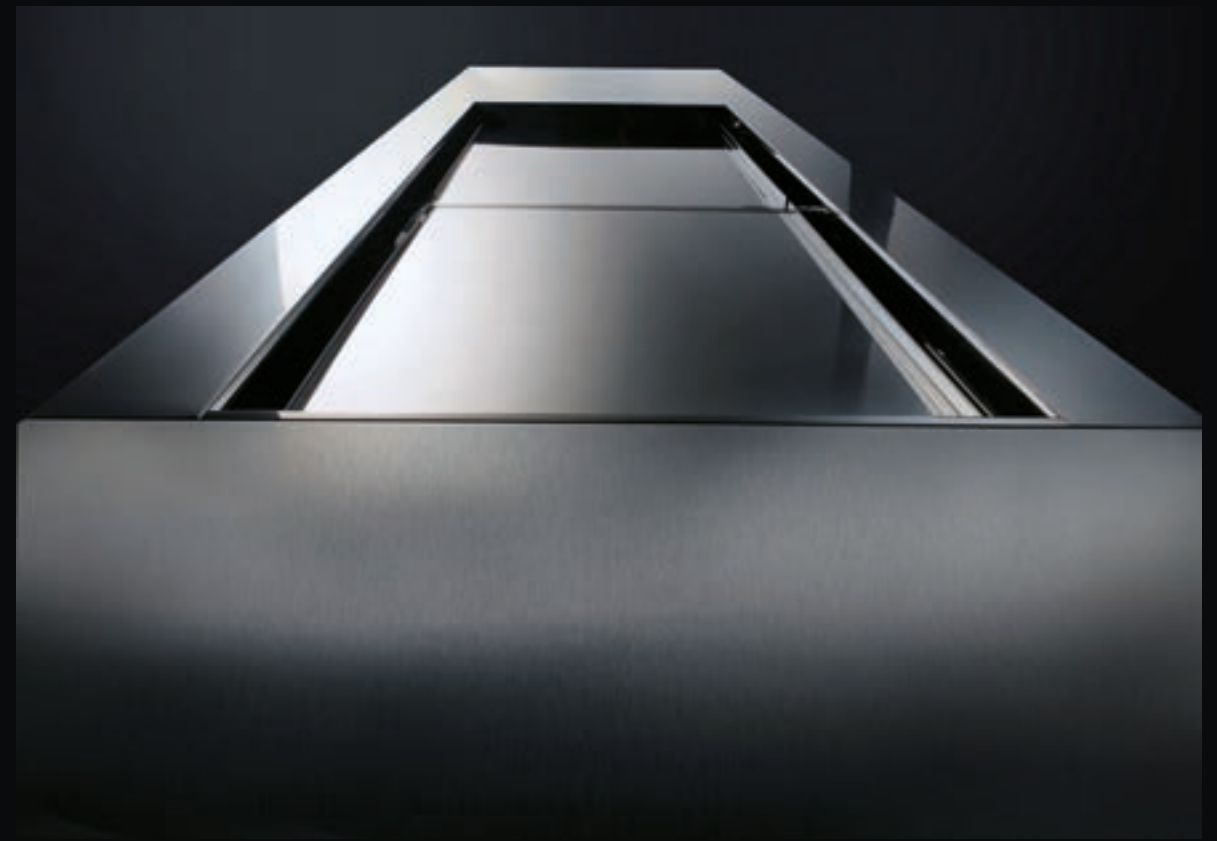

Vasche pasticceria canalizzabili.
Unico piano di qualsiasi lunghezza
per aumentare la visibilità del prodotto.

Modular pastry tanks.
Single top of any length to increase
product visibility.

LA SEMPLICITÀ DELLA PERFEZIONE

THE SIMPLICITY OF PERFECTION

L'apertura con pistoni a gas (45°) grazie ad un'accurata progettazione, permette in un solo gesto di alzare il corpo refrigerante e il piano espositivo. L'assenza di ulteriori particolari sul fondo della vasca semplifica le operazioni di manutenzione e di pulizia a tutto vantaggio dell'igiene e del comfort di utilizzo.

The opening system with gas pistons (45°), thanks to careful design, allows raising the cooler unit and the display top with a single movement. The absence of further elements on the bottom of the tank simplifies the operations of maintenance and cleaning for better hygiene and ease of use.

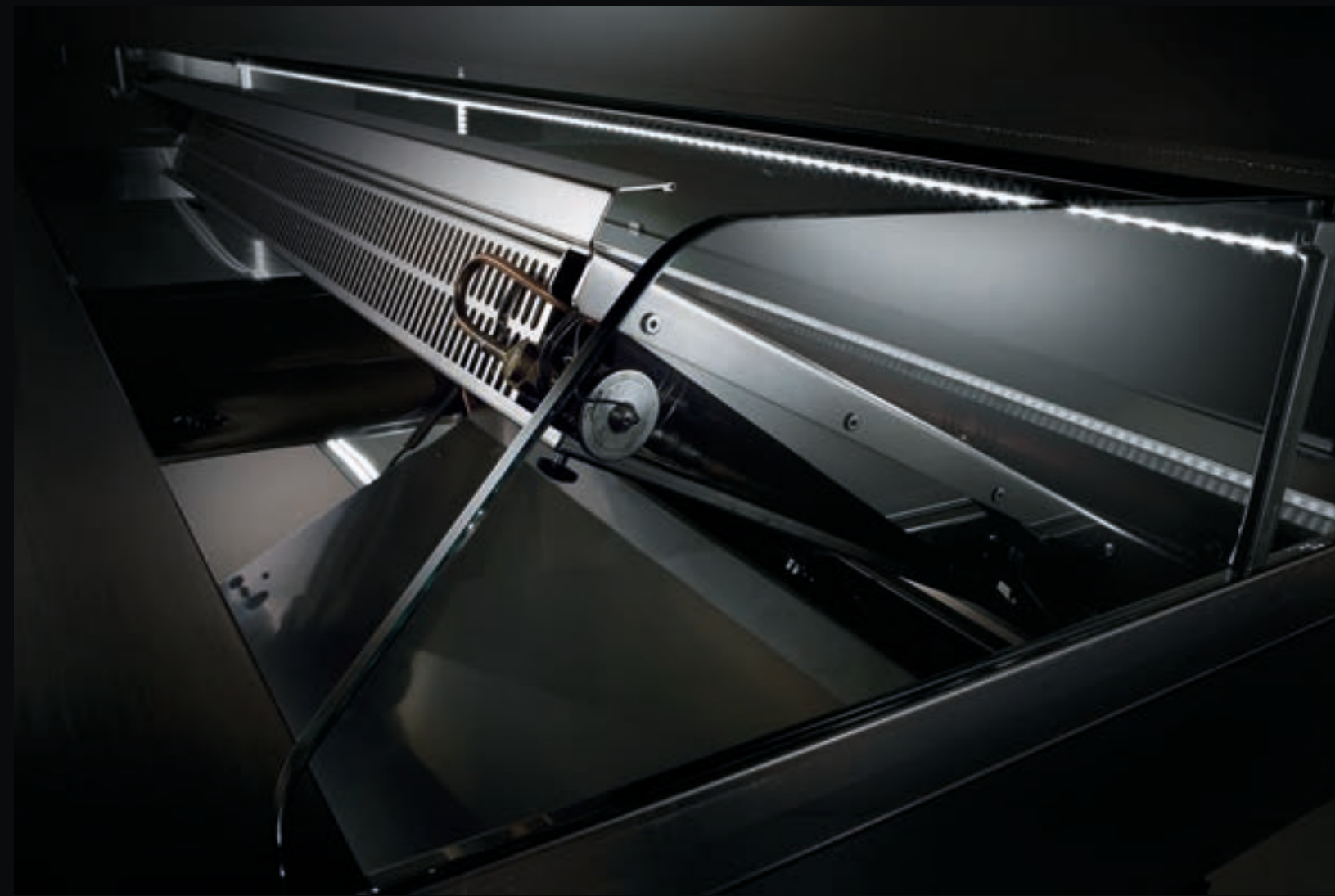
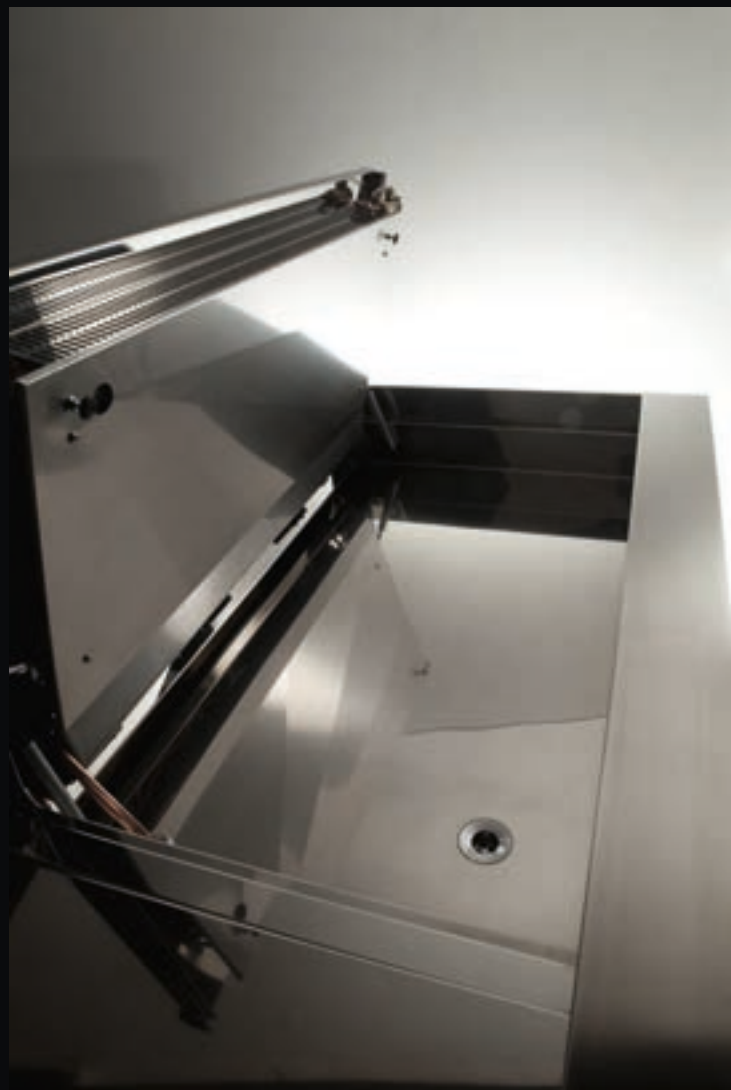

VERSATILE ALLA PERSONALIZZAZIONE

FLEXIBLE CUSTOMIZATION

Le nostre vasche sono studiate per adattarsi ad ogni tipo di materiale, perfette per qualsiasi tipo di rivestimento, per ottenere sempre il risultato estetico desiderato.

Our tanks are designed to fit any type of material, perfect for any type of finishing to consistently achieve the desired aesthetic result.



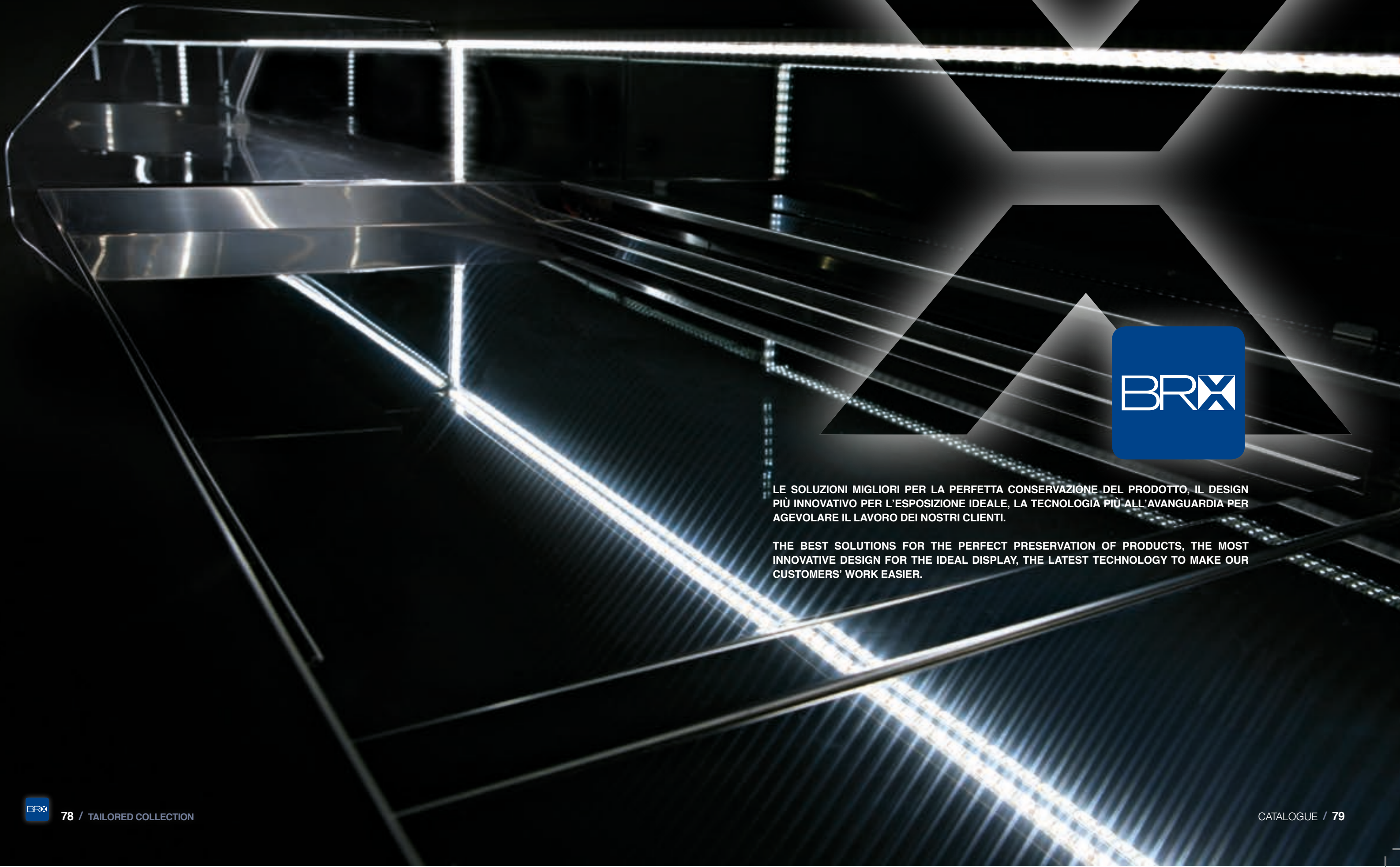

LE SOLUZIONI MIGLIORI PER LA PERFETTA CONSERVAZIONE DEL PRODOTTO, IL DESIGN PIÙ INNOVATIVO PER L'ESPOSIZIONE IDEALE, LA TECNOLOGIA PIÙ ALL'AVANGUARDIA PER AGEVOLARE IL LAVORO DEI NOSTRI CLIENTI.

THE BEST SOLUTIONS FOR THE PERFECT PRESERVATION OF PRODUCTS, THE MOST INNOVATIVE DESIGN FOR THE IDEAL DISPLAY, THE LATEST TECHNOLOGY TO MAKE OUR CUSTOMERS' WORK EASIER.

BANCHI BAR

BAR COUNTERS



*DALLA COLAZIONE AL COCKTAIL:
IDEALE IN OGNI MOMENTO
DELLA GIORNATA
FROM BREAKFAST TO COCKTAILS:
IDEAL EVERY MOMENT OF THE DAY*

Banchi bar dalla progettualità versatile, personalizzabili nelle misure e nelle composizioni per creare ambienti ideali ad accogliere ogni tipologia di servizio, dalla colazione al dopo cena, ottimizzando gli spazi garantendo risultati sempre unici e originali.

Bar counters with flexible design, customizable in sizes and compositions to create the ideal setting and accommodate every type of service, from breakfast to after dinner, optimizing spaces and ensuring always unique and original results.



IL MIGLIOR SUPPORTO ALLA CREATIVITÀ

THE BEST SUPPORT FOR CREATIVITY

CREA IL BAR DEI TUOI DESIDERI: BRX TI OFFRE IL SUPPORTO IDEALE PER POTER LAVORARE AL MEGLIO, GRAZIE ALLA VERSATILITÀ DI UN PRODOTTO CHE SI ADATTA A DIFFERENTI ESIGENZE DI SPAZIO E DI COMPOSIZIONE.

CREATE THE BAR OF YOUR DREAMS: BRX OFFERS THE IDEAL SUPPORT FOR THE BEST RESULT, THANKS TO THE VERSATILITY OF A PRODUCT THAT FITS DIFFERENT NEEDS OF SPACE AND COMPOSITION.



LA NOSTRA IDEA DI PROFESSIONALE

OUR IDEA OF PROFESSIONALISM



Non solo curati da un punto di vista estetico, ma anche intelligentemente accessoriati con contenitori capienti: cella frigorifera inserita nel banco macchina caffè per avere ciò che serve a portata di mano.

Not only designed with aesthetics in mind, but also cleverly equipped with spacious compartments: the refrigerator unit inserted in the coffee-machine counter to keep everything handy.



LED LUMINOSI CATTURANO LO SGUARDO

LED LIGHTS CATCH THE EYE





Prodotti fatti per durare nel tempo.
Interni rivestiti in acciaio, resistenti
e belli da vedere.

Products made to last.
Interior coated in steel, resistant
and beautiful to see.





Speciali carter di protezione riparano valvole e tubi di rame rendendo gli interni esteticamente più curati.

Special protective casings house copper pipes and valves, making the interiors more aesthetically refined.





LA BELLEZZA SI METTE IN MOSTRA

BEAUTY SHOWS OFF



LA MATERIA SI VESTE DI LUCE E TRASPARENZA

LIGHT AND TRANSPARENCY DRESSING THE MATERIALS



DIFFERENTI TIPOLOGIE DI TEMPERATURA PER DIVERSI MODI DI ESPORRE

DIFFERENT TEMPERATURE SETTINGS FOR DIFFERENT DISPLAY NEEDS



FORME LINEARI O ARROTONDATE PER DIVERSE SCELTE D'ARREDO

LINEAR OR ROUNDED SHAPES
FOR DIFFERENT CHOICES OF FURNITURE



Vetrine refrigeranti o riscaldanti.
Vani completamente rifiniti all'interno
in acciaio inox per risultati di pregio.

Refrigerating or heating display
cabinets completely finished internally
with stainless steel for fine results.

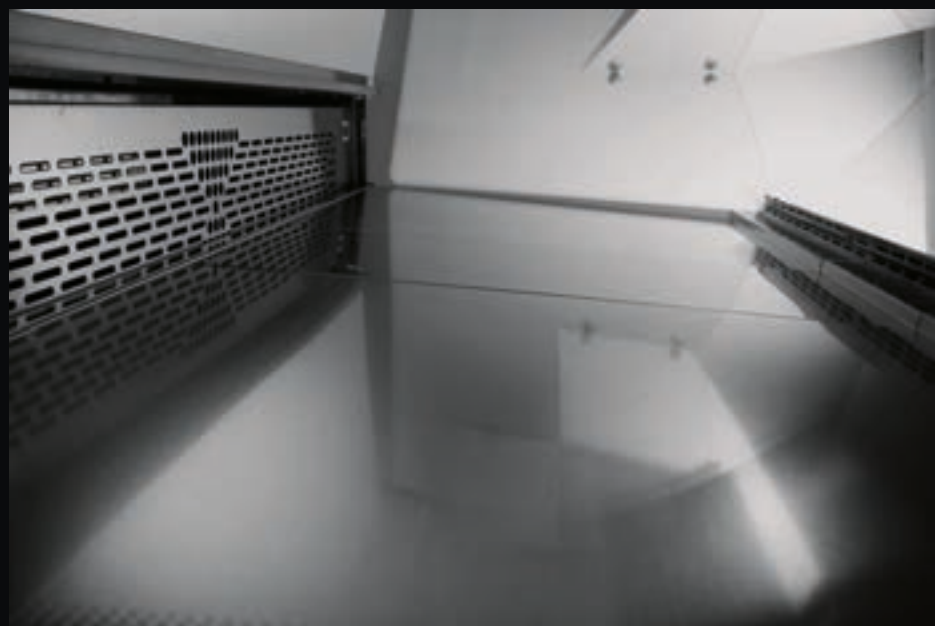

AD OGNI SPAZIO LA SUA COMPOSIZIONE

TO EVERY SPACE ITS COMPOSITION

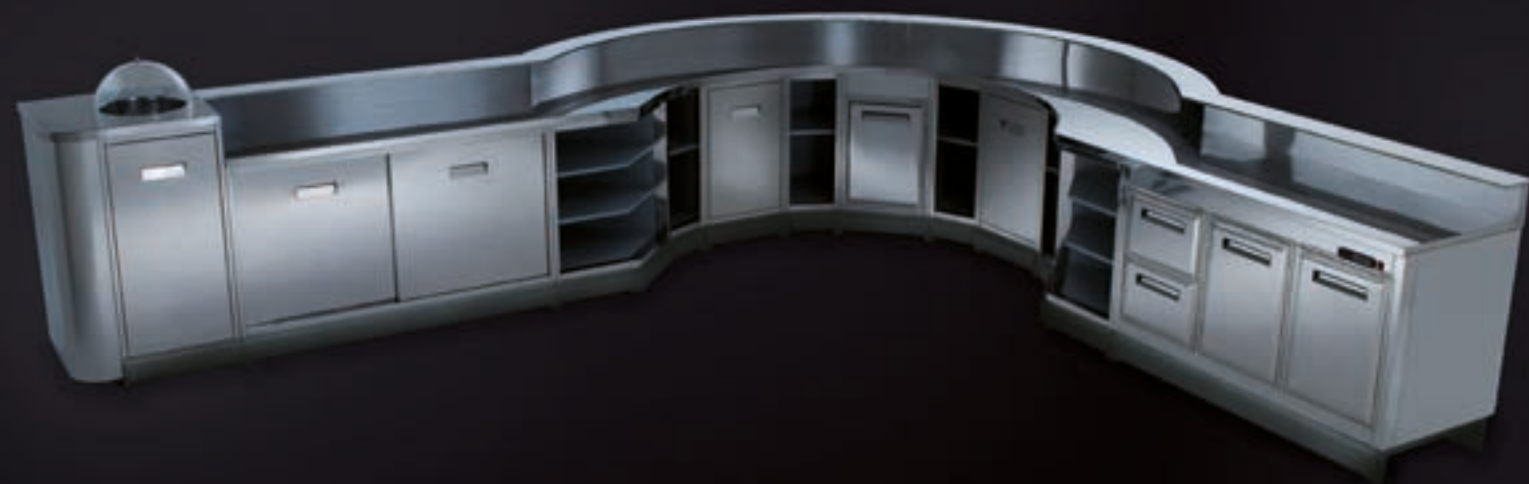

SCEGLI LA FORMA DELL'ERGONOMIA

CHOOSING THE SHAPE OF ERGONOMICS

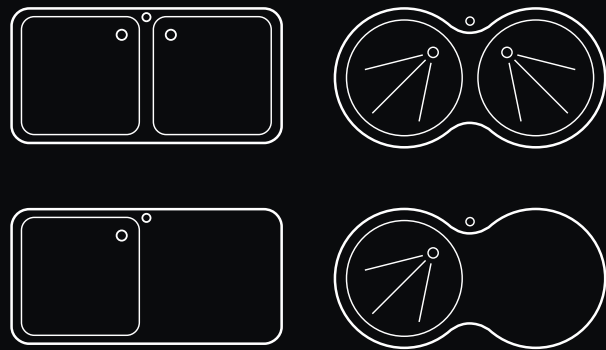

l'invaso stampato si può scegliere sagomato o rettangolare, con vasca doppia o singola.

The moulded drip edge can be chosen with a shaped or rectangular profile and in a single or double tank version.

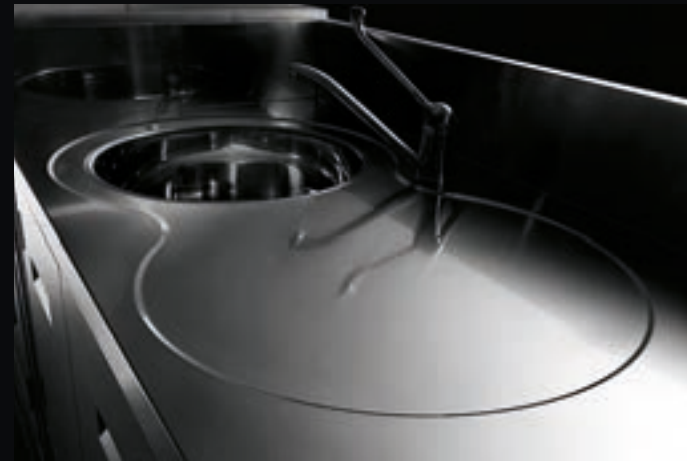

Top arrotondato per tavolo da lavoro o su richiesta per banco bar.
Angoli smussati con o senza alzatina: più facile la pulizia e niente spigoli vivi per una migliore ergonomia.

The rounded top for work counters, or on request, for the bar counter.

Rounded corners with or without back panel: easier to clean and no sharp edges for improved ergonomics.





TECNOLOGIA E FLESSIBILITÀ: ABBIAMO LA RISPOSTA GIUSTA AD OGNI VOSTRA RICHIESTA

TECHNOLOGY AND FLEXIBILITY:
WE HAVE THE RIGHT ANSWER TO EVERY QUESTION

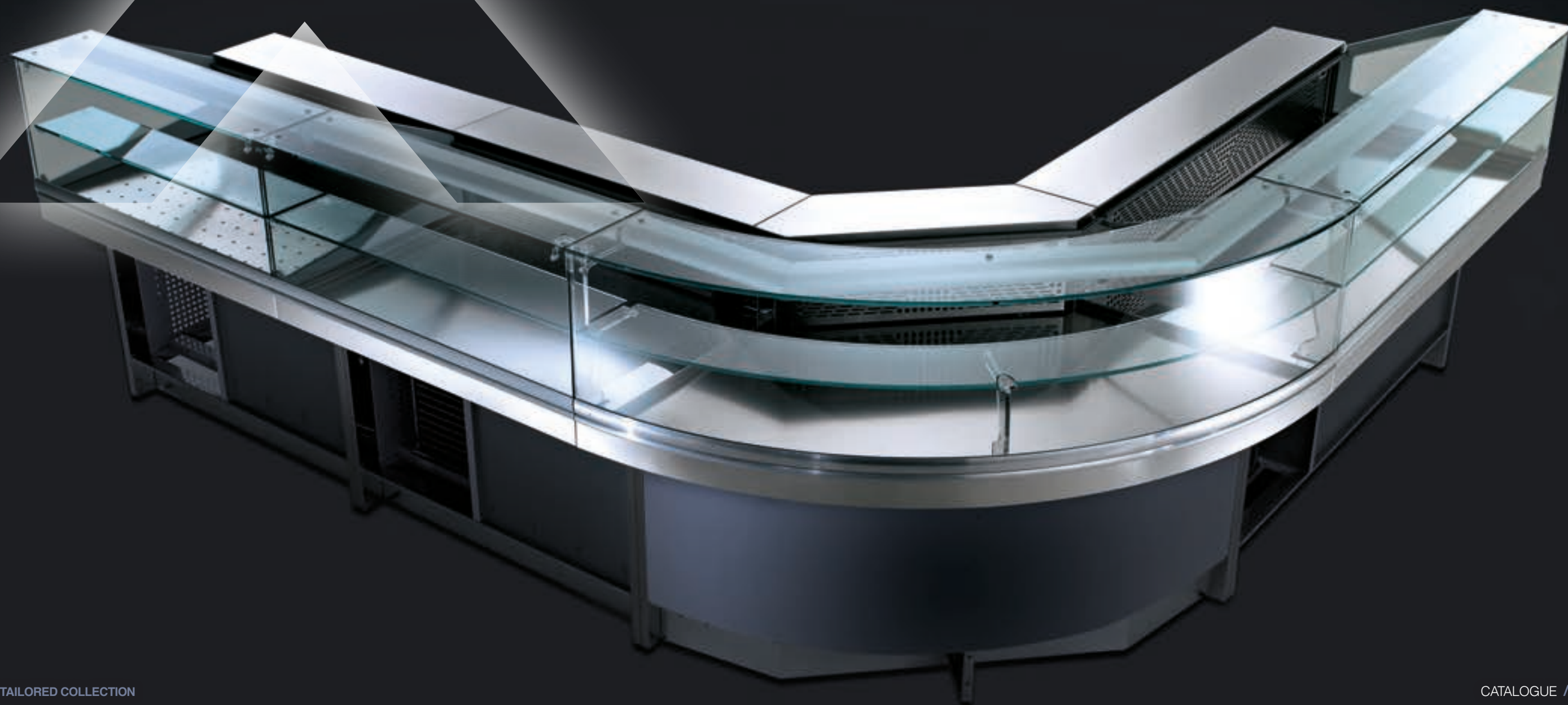



AD **BRX**

Photography
Livio Fantozzi

September 2012

